

- NL** Montage-instructies Verstelbaar-vast beslag
- DE** Montageanleitung Verstellbar-feste Beschläge
- EN** Installation instructions Adjustable-fixed fittings

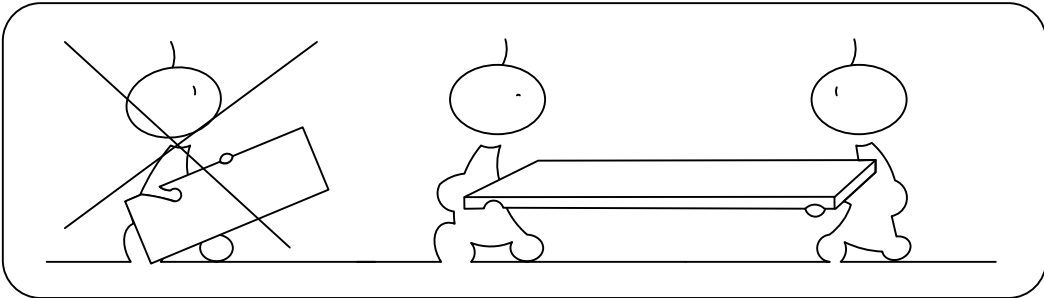

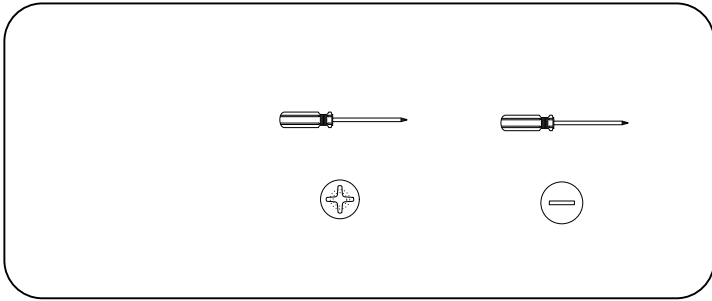

A, B, C, D + I, J, K + N

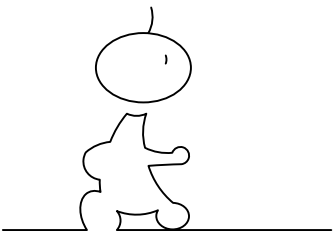
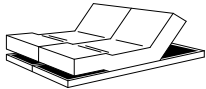
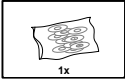
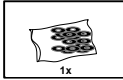
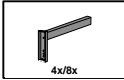
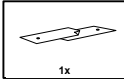
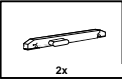
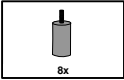
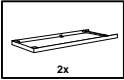
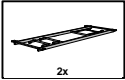
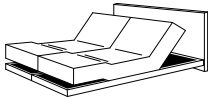

A, B, C, D + G + I, J, K, L + N

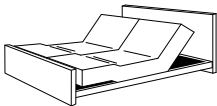

A + E, F, G, H, I, J, K, L, M, N

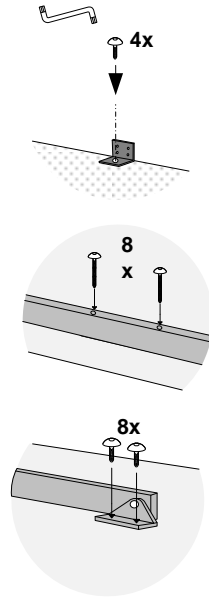
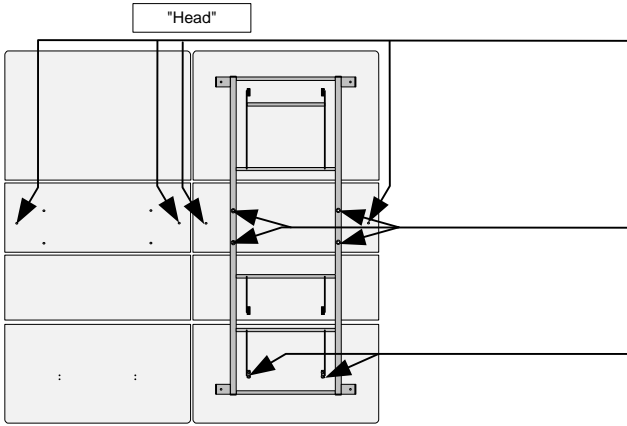
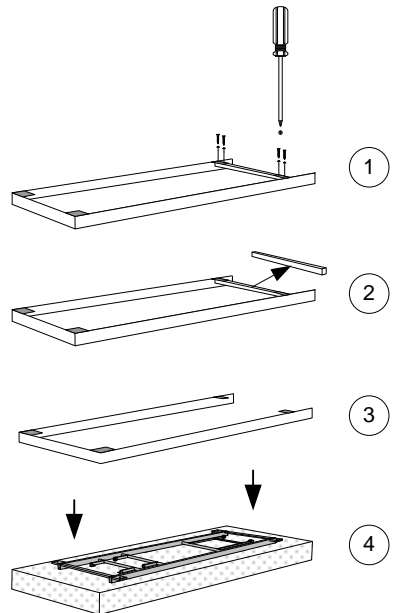
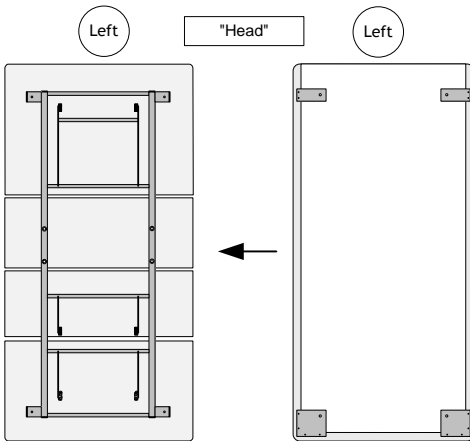
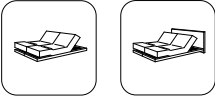
A**B**

C

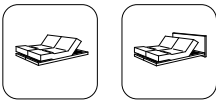

"Head"

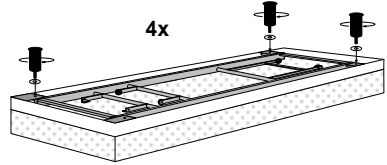
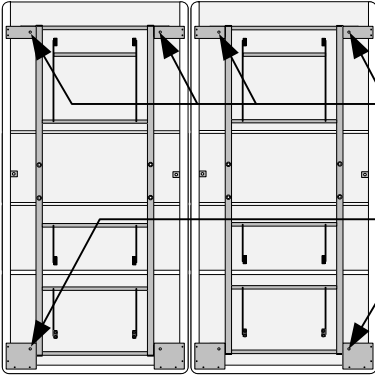

D

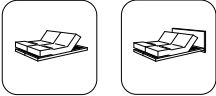

"Head"

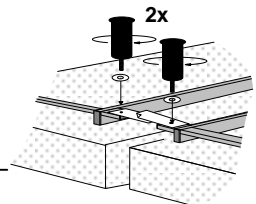
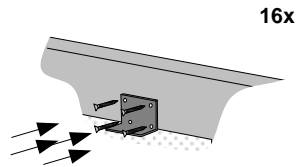
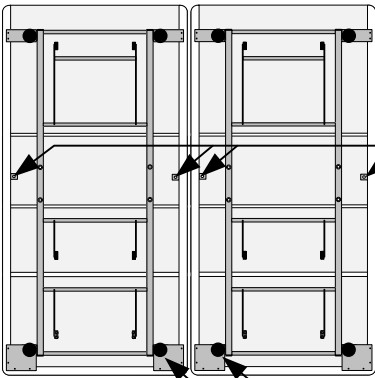

E

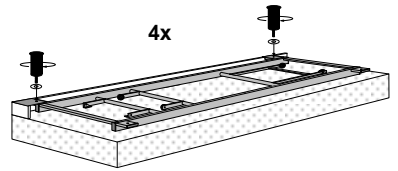
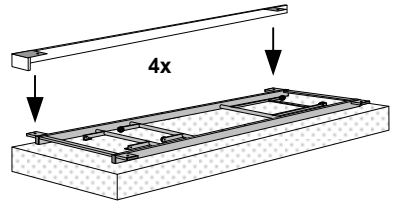
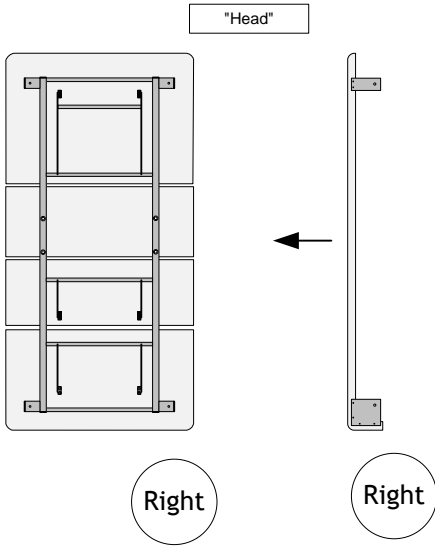

F

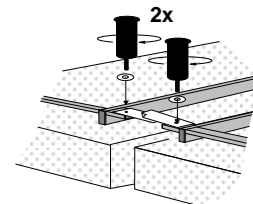
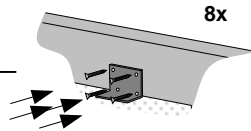
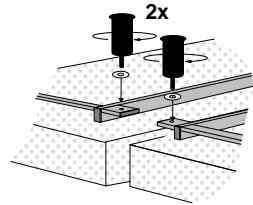
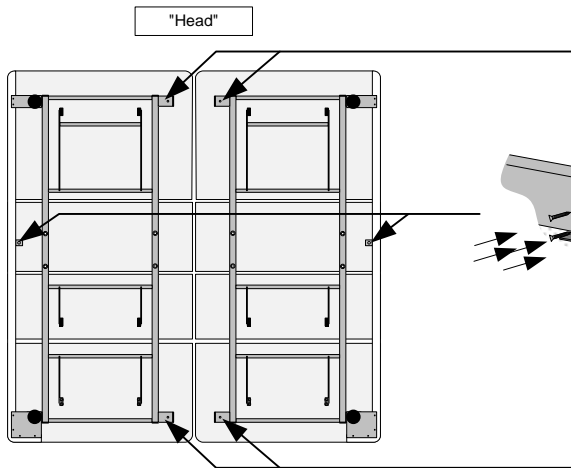

G

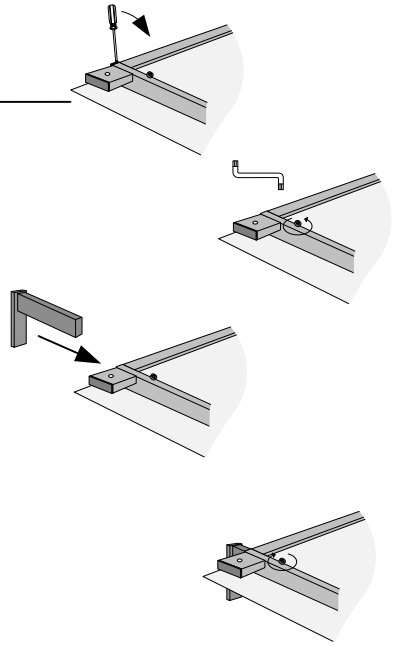
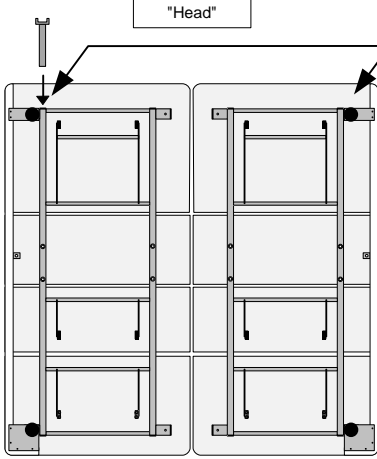
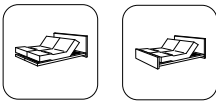

H

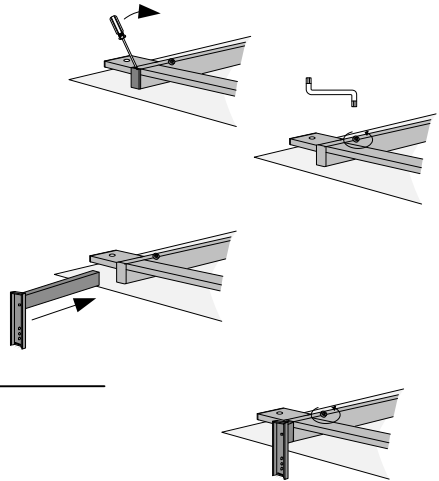
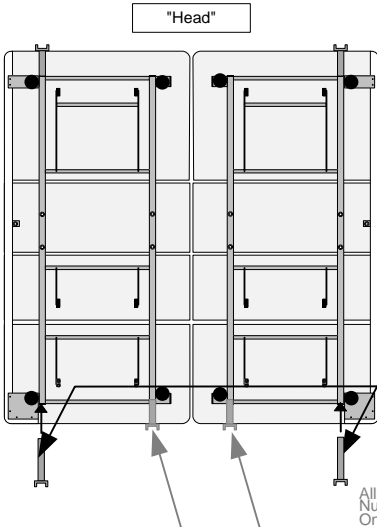

Alleen bij zwevend voetbord
 Nur mit schwebendes Fußbrett
 Only with floating footboard

I

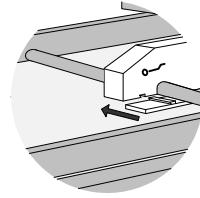
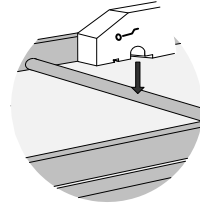
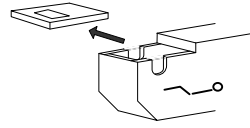
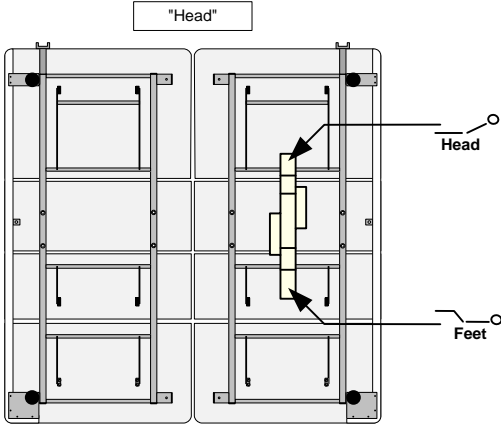

J

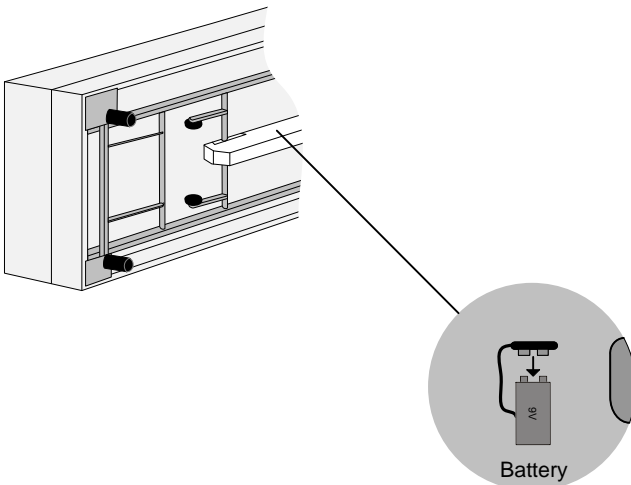

K

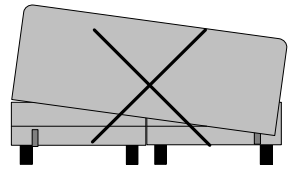
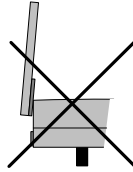
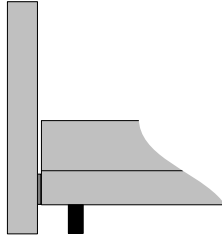
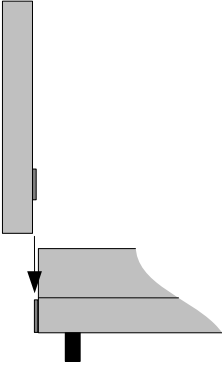

L

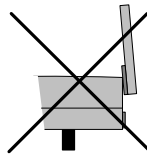
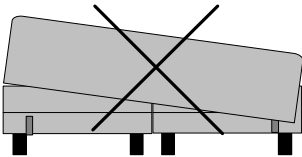
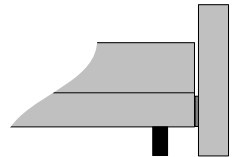
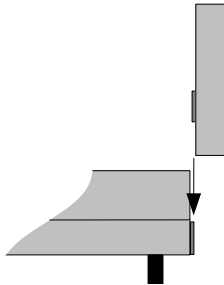

M

